



Caratteristiche:

Griglie di ripresa ad alette fisse inclinate di 45° passo 25 mm.

Costruzione:

Alluminio anodizzato.

Impiego:

A parete, in ripresa.

Fissaggio:

- Fissaggio standard con clips.
- Fori per viti a richiesta.
- Calamite a richiesta.
- Morsetti a richiesta.

Accessori:

- Plenum in acciaio zincato standard o isolato.
- Serranda di taratura in acciaio zincato con alette a movimento contrapposto.
- Controtelaio di montaggio in lamiera di acciaio zincata.

Characteristics:

Return grilles with fixed and 45° inbined bars 25 mm pitch.

Construction:

Anodized aluminium.

Utilization:

For wall installation and for air intake.

Fixing:

- Standard fixing by clips.
- Holes for screws upon request.
- Magnets on request.
- Lock upon request.

Accessories:







- Galvanized steel plenum, standard or insulated.
- Calibration damper made of galvanized steel and fins with opposite movement.
- Mounting counterframes made of galvanized steel sheet.

PREZZI / PRICES

	GRA	GRA-R	GRA-R-Z	GRA-R-SS	SC	CT	PBZ 1	PBZI 1	PBZ 2	PBZI 2	
BxH (mm)	€	€	€	€	€	€	€	€	€	€	
* 200x100	-	-	-	-	-	-	-	-	-	-	
* 300x100	-	-	-	-	-	-	-	-	-	-	
* 400x100	-	-	-	-	-	-	-	-	-	-	
* 500x100	-	-	-	-	-	-	-	-	-	-	
* 600x100	-	-	-	-	-	-	-	-	-	-	
• 800x100	-	-	-	-	-	-	-	-	-	-	
• 1000x100	-	-	-	-	-	-	-	-	-	-	
• 1200x100	-	-	-	-	-	-	-	-	-	-	
* 200x150	-	-	-	-	-	-	-	-	-	-	
* 300x150	-	-	-	-	-	-	-	-	-	-	
* 400x150	-	-	-	-	-	-	-	-	-	-	
* 500x150	-	-	-	-	-	-	-	-	-	-	
* 600x150	-	-	-	-	-	-	-	-	-	-	
• 800x150	-	-	-	-	-	-	-	-	-	-	
• 1000x150	-	-	-	-	-	-	-	-	-	-	
• 1200x150	-	-	-	-	-	-	-	-	-	-	
* 200x200	-	-	-	-	-	-	-	-	-	-	
* 300x200	-	-	-	-	-	-	-	-	-	-	
* 400x200	-	-	-	-	-	-	-	-	-	-	
* 500x200	-	-	-	-	-	-	-	-	-	-	
* 600x200	-	-	-	-	-	-	-	-	-	-	
• 800x200	-	-	-	-	-	-	-	-	-	-	
• 1000x200	-	-	-	-	-	-	-	-	-	-	
• 1200x200	-	-	-	-	-	-	-	-	-	-	
* 200x300	-	-	-	-	-	-	-	-	-	-	
* 300x300	-	-	-	-	-	-	-	-	-	-	
* 400x300	-	-	-	-	-	-	-	-	-	-	
* 500x300	-	-	-	-	-	-	-	-	-	-	
* 600x300	-	-	-	-	-	-	-	-	-	-	
• 800x300	-	-	-	-	-	-	-	-	-	-	
• 1000x300	-	-	-	-	-	-	-	-	-	-	
• 1200x300	-	-	-	-	-	-	-	-	-	-	
200x400	-	-	-	-	-	-	-	-	-	-	
* 300x400	-	-	-	-	-	-	-	-	-	-	
* 400x400	-	-	-	-	-	-	-	-	-	-	
* 500x400	-	-	-	-	-	-	-	-	-	-	
* 600x400	-	-	-	-	-	-	-	-	-	-	
• 800x400	-	-	-	-	-	-	-	-	-	-	
• 1000x400	-	-	-	-	-	-	-	-	-	-	
• 1200x400	-	-	-	-	-	-	-	-	-	-	
200x500	-	-	-	-	-	-	-	-	-	-	
300x500	-	-	-	-	-	-	-	-	-	-	
400x500	-	-	-	-	-	-	-	-	-	-	
500x500	-	-	-	-	-	-	-	-	-	-	
600x500	-	-	-	-	-	-	-	-	-	-	

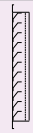
• Rinforzo intermedio / Intermediate reinforcing

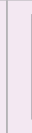
PREZZI / PRICES

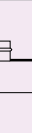
										
	GRA	GRA-R	GRA-R-Z	GRA-R-SS	SC	CT	PBZ 1	PBZI 1	PBZ 2	PBZI 2
BxH (mm)	€	€	€	€	€	€	€	€	€	€
• 800x500	-	-	-	-	-	-	-	-	-	-
• 1000x500	-	-	-	-	-	-	-	-	-	-
• 1200x500	-	-	-	-	-	-	-	-	-	-
200x600	-	-	-	-	-	-	-	-	-	-
300x600	-	-	-	-	-	-	-	-	-	-
400x600	-	-	-	-	-	-	-	-	-	-
500x600	-	-	-	-	-	-	-	-	-	-
600x600	-	-	-	-	-	-	-	-	-	-
• 800x600	-	-	-	-	-	-	-	-	-	-
• 1000x600	-	-	-	-	-	-	-	-	-	-
• 1200x600	-	-	-	-	-	-	-	-	-	-
200x800	-	-	-	-	-	-	-	-	-	-
300x800	-	-	-	-	-	-	-	-	-	-
400x800	-	-	-	-	-	-	-	-	-	-
500x800	-	-	-	-	-	-	-	-	-	-
600x800	-	-	-	-	-	-	-	-	-	-
• 800x800	-	-	-	-	-	-	-	-	-	-
• 1000x800	-	-	-	-	-	-	-	-	-	-
• 1200x800	-	-	-	-	-	-	-	-	-	-
595x595 E.C. esterno cornice overall size	-	-	-	-	-	-	-	-	-	-

Per misure fuori tabella prezzi a richiesta

For bigger sizes prices on request

• Rinforzo intermedio / Intermediate reinforcing

VERNICIATURA:

Colori RAL 9010 - 9016 - 7035: + 15%

Altri colori: prezzi a richiesta

DESCRIZIONI:

GRA: Griglia di ripresa passo 25 mm

GRA-R: Griglia di ripresa passo 25 mm con rete antivolatile

GRA-R-Z: Griglia di ripresa passo 25 mm con rete anti insetto (zanzariera)

GRA-R-SS-A: Griglia di ripresa passo 25 mm con rete antivolatile e serranda di sovrappressione a gravità (aspirazione)

GRA-R-SS-E: Griglia di ripresa passo 25 mm con rete antivolatile e serranda di sovrappressione a gravità (espulsione)

ESECUZIONI SU RICHIESTA:

- Griglia completa di tegolo anti-pioggia +TEG

ACCESSORI:

SC: Serranda di taratura ad alette con movimento contapposto

CT: Controtelaio di fissaggio in lamiera d'acciaio zincata

PBZ: Plenum di raccordo

PAINING:

Color RAL 9010 - 9016 - 7035: + 15%

Different colors: prices on request

DESCRIZIONI:

GRA: Return grille (25 mm between bars)

GRA-R: Return grille (25 mm between bars) with bird mesh

GRA-R-Z: Return grille (25 mm between bars) with insect screen.

GRA-R-SS-A: Return grille (25 mm between bars) with bird mesh and overpressure damper (aspiration)

GRA-R-SS-E: Return grille (25 mm between bars) with bird mesh and overpressure damper (expulsion)

AVAILABLE ON REQUEST:

- Grille with rain-proof panel +TEG

ACCESSORIES:

SC: Opposed blade damper

CT: Counterframes in galvanised steel sheet profile section

PBZ: Connecting plenum

DISEGNI / DRAWINGS

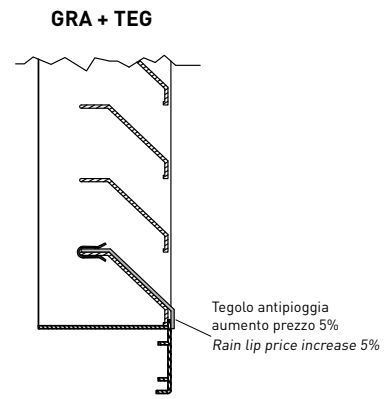
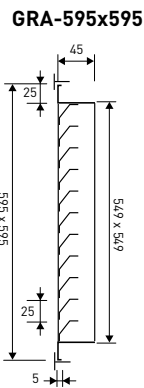
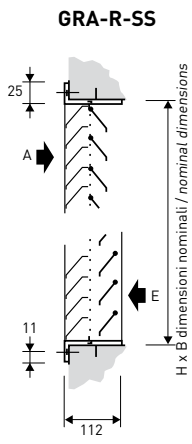
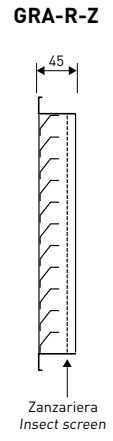
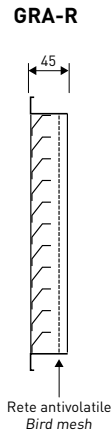
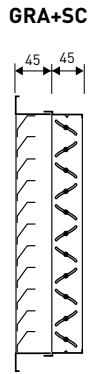
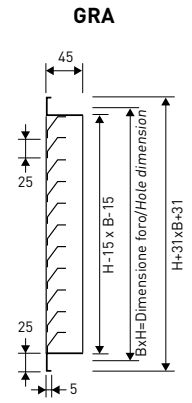

TIPO DI FISSAGGIO / TYPE OF FIXING

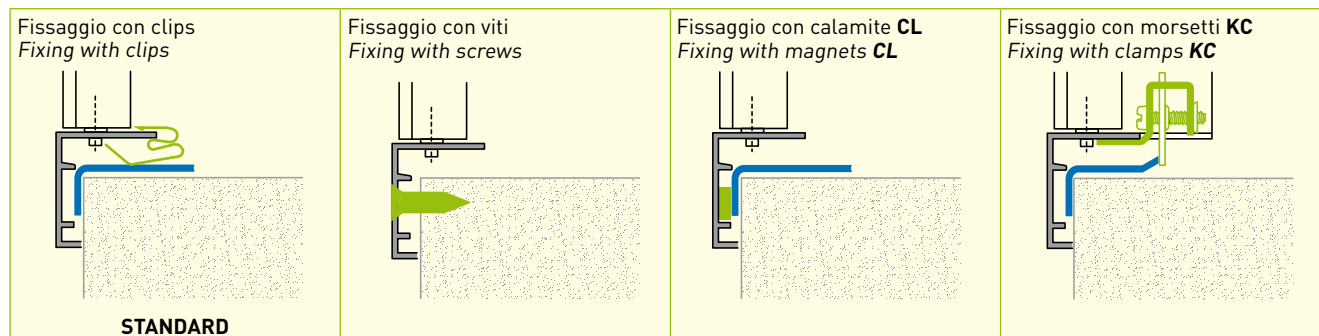

FORI / HOLES

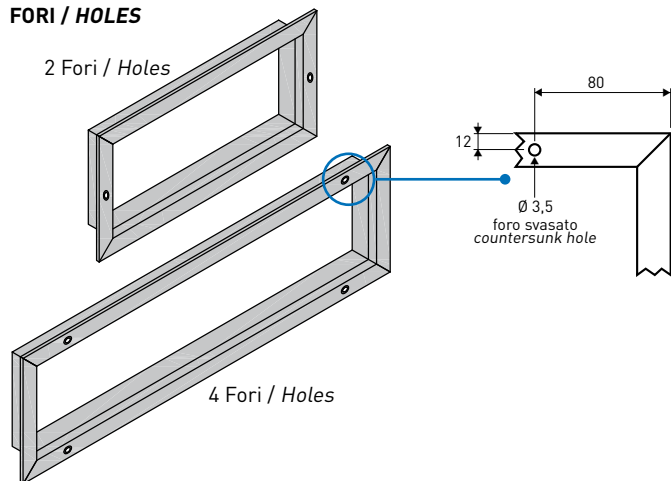

Quantità di fori per le viti di fissaggio Amount of holes for mounting screw					
Lato minore Smaller side	Lato maggiore / Longer side				
	200	250	300	350	≥400
100	2	2	2	4	4
150	2	2	2	4	4
200	2	2	2	4	4
≥250	2	2	2	4	4

DISEGNI / DRAWINGS

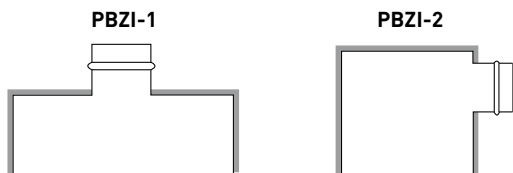
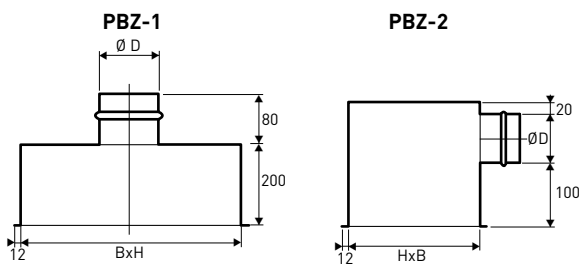

Plenum isolato esternamente spessore 6 mm
Plenum externally insulated thickness 6 mm

DIAGRAMMA SCELTA RAPIDA / QUICK SELECTION DIAGRAM

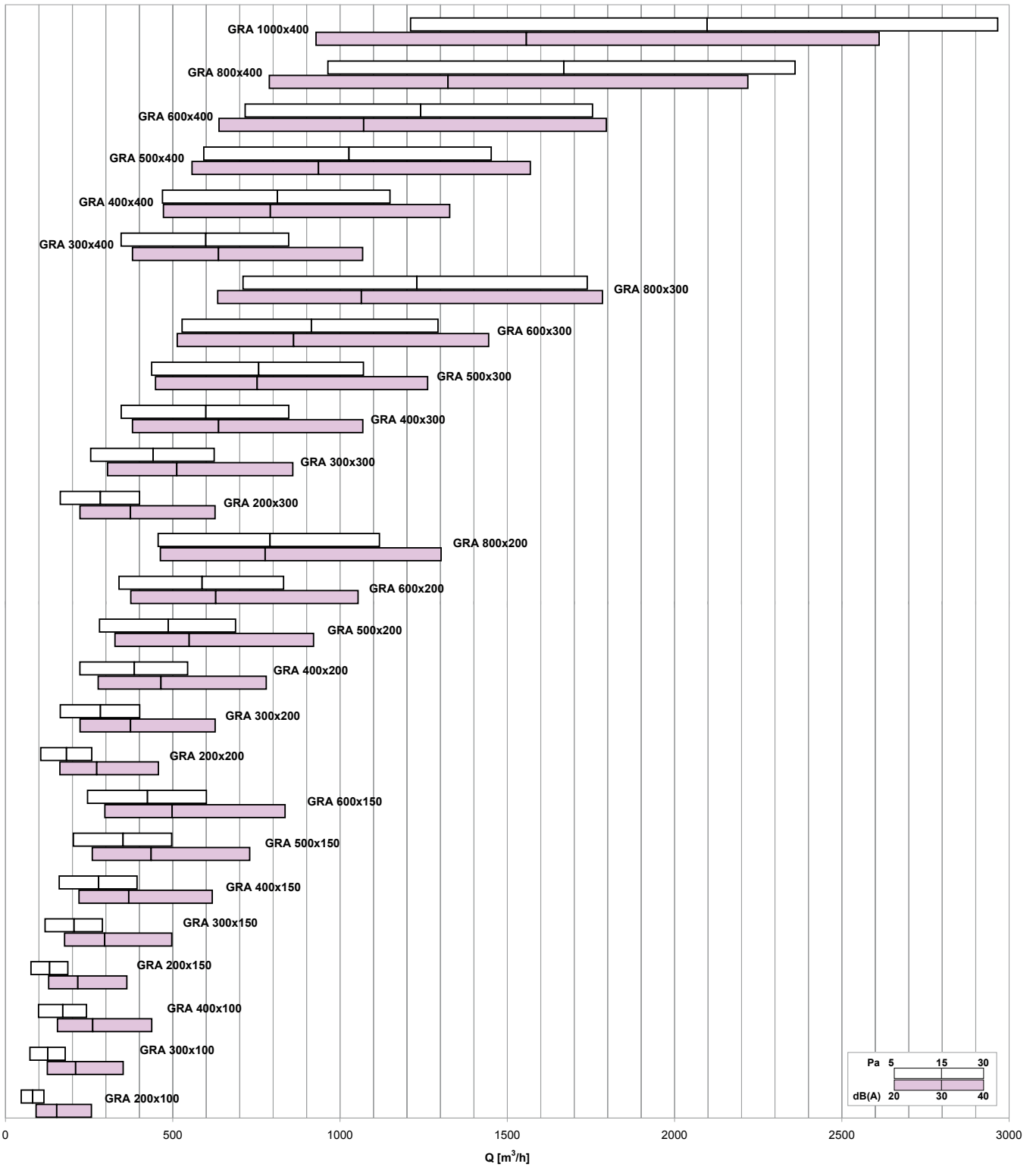

TABELLA DI SELEZIONE / SELECTION TABLE

Modello Model	A _v [m ²]	Q [m ³ /h]		L _{WA} [dB(A)]		Dp _t [Pa]	
		min	max	min	max	min	max
GRA 200x100	0,0101	50	120	-	25	5	30
GRA 300x100	0,0157	70	180	-	27	5	30
GRA 400x100	0,0213	100	240	-	28	5	30
GRA 500x100	0,0269	120	310	-	30	5	30
GRA 600x100	0,0325	150	370	-	31	5	30
GRA 800x100	0,0437	200	500	-	33	5	30
GRA 1000x100	0,0548	250	620	-	34	5	30
GRA 1200x100	0,0660	310	750	-	35	5	30
GRA 200x150	0,0164	80	190	-	27	5	30
GRA 300x150	0,0255	120	290	-	30	5	30
GRA 400x150	0,0346	160	390	-	31	5	30
GRA 500x150	0,0437	200	500	-	33	5	30
GRA 600x150	0,0528	250	600	-	34	5	30
GRA 800x150	0,0709	330	810	-	35	5	30
GRA 1000x150	0,0891	410	1010	-	36	5	30
GRA 1200x150	0,1073	500	1220	20	38	5	30
GRA 200x200	0,0227	110	260	-	29	5	30
GRA 300x200	0,0353	160	400	-	31	5	30
GRA 400x200	0,0478	220	540	-	33	5	30
GRA 500x200	0,0604	280	690	-	34	5	30
GRA 600x200	0,0730	340	830	-	35	5	30
GRA 800x200	0,0982	460	1120	-	37	5	30
GRA 1000x200	0,1234	570	1400	21	38	5	30
GRA 1200x200	0,1486	690	1690	22	39	5	30
GRA 200x300	0,0352	160	400	-	31	5	30
GRA 300x300	0,0548	250	620	-	34	5	30
GRA 400x300	0,0744	350	850	-	36	5	30
GRA 500x300	0,0940	440	1070	-	37	5	30
GRA 600x300	0,1136	530	1290	21	38	5	30
GRA 800x300	0,1528	710	1740	22	40	5	30
GRA 1000x300	0,1920	890	2190	23	41	5	30
GRA 1200x300	0,2312	1070	2630	24	42	5	30
GRA 200x400	0,0478	220	540	-	33	5	30
GRA 300x400	0,0744	350	850	-	36	5	30
GRA 400x400	0,1010	470	1150	-	37	5	30
GRA 500x400	0,1276	590	1450	21	38	5	30
GRA 600x400	0,1542	720	1750	22	39	5	30
GRA 800x400	0,2073	960	2360	24	41	5	30
GRA 1000x400	0,2605	1210	2970	25	42	5	30
GRA 1200x400	0,3137	1460	3570	26	43	5	30
GRA 200x500	0,0603	280	690	-	34	5	30
GRA 300x500	0,0939	440	1070	-	37	5	30
GRA 400x500	0,1275	590	1450	21	38	5	30
GRA 500x500	0,1611	750	1830	23	40	5	30
GRA 600x500	0,1947	900	2220	23	41	5	30
GRA 800x500	0,2619	1220	2980	25	42	5	30
GRA 1000x500	0,3291	1530	3750	26	44	5	30
GRA 1200x500	0,3963	1840	4510	27	45	5	30
GRA 200x600	0,0729	340	830	-	35	5	30
GRA 300x600	0,1135	530	1290	21	38	5	30
GRA 400x600	0,1541	720	1750	22	40	5	30
GRA 500x600	0,1947	900	2220	23	41	5	30
GRA 600x600	0,2353	1090	2680	25	42	5	30
GRA 800x600	0,3165	1470	3600	26	44	5	30
GRA 1000x600	0,3977	1850	4530	28	45	5	30
GRA 1200x600	0,4789	2230	5450	29	46	5	30
GRA 200x800	0,0980	460	1120	-	37	5	30
GRA 300x800	0,1526	710	1740	22	40	5	30
GRA 400x800	0,2072	960	2360	24	41	5	30
GRA 500x800	0,2618	1220	2980	25	42	5	30
GRA 600x800	0,3164	1470	3600	26	44	5	30
GRA 800x800	0,4256	1980	4850	28	45	5	30
GRA 1000x800	0,5348	2490	6090	29	46	5	30
GRA 1200x800	0,6440	2990	7330	30	47	5	30
GRA 595x595	0,1957	910	2230	24	41	5	30